

Fair Housing Act Checklist

A Guide to Accessible Design and
Construction Compliance



The Equal Rights Center

About the Author

The author is a professional writer with a background in journalism and editing. She has worked for several years at a major newspaper, where she covered a wide range of topics, from local news to international affairs. Her writing is known for its clarity, depth, and ability to engage a diverse audience. She has also contributed to various magazines and online platforms, where she continues to explore her interests in social issues, culture, and the environment. Her most recent work includes a collection of essays on the impact of technology on society, which has received critical acclaim and a readership across the globe.

The author is a professional writer with a background in journalism and editing. She has worked for several years at a major newspaper, where she covered a wide range of topics, from local news to international affairs. Her writing is known for its clarity, depth, and ability to engage a diverse audience. She has also contributed to various magazines and online platforms, where she continues to explore her interests in social issues, culture, and the environment. Her most recent work includes a collection of essays on the impact of technology on society, which has received critical acclaim and a readership across the globe.

Professional Training

Journalism

Education

Writing and Editing

Work Experience

Freelance Writing

Contents

Introduction	2
Requirement 1: Accessible building entrance on an accessible route	3
Requirement 2: Accessible and usable common and public use areas	7
Requirement 3: Usable doors	20
Requirement 4: Accessible route into and through the covered dwelling unit	25
Requirement 5: Light switches, electrical outlets, thermostats and environmental controls in accessible locations	28
Requirement 6: Reinforced walls for grab bars	31
Requirement 7: Usable kitchens and bathrooms	33

© The Equal Rights Center 2013—All Rights Reserved

The work that provided the basis for this publication was supported by funding under a grant with the U.S. Department of Housing and Urban Development. The substance and findings of the work are dedicated to the public. The author and publisher are solely responsible for the accuracy of the statements and interpretations contained in this publication. Such interpretations do not necessarily reflect the views of the Federal Government.

Introduction

The purpose of the Fair Housing Act Checklist: A Guide to Accessible Design and Construction Compliance (FHA Checklist) is to highlight regulations as they apply to covered multifamily dwellings. Covered multifamily dwellings are defined by the Fair Housing Act (FHA) as buildings with four or more dwelling units that are newly constructed for first occupancy on or after March 13, 1991. All covered buildings, as well as the covered units within, are required to meet the accessibility regulations of the Fair Housing Act.

This checklist is organized along the seven technical requirements of the FHA; certain deviations in sequencing have been made to enhance the usability of the checklist during a site survey. Images featured throughout this publication are taken from the U.S. Department of Housing and Urban Development (HUD), Fair Housing Act Design Manual and the Institute for Human Centered Design.

This document is not a safe harbor for compliance with the FHA. Departures from this checklist may still result in compliance provided that the alternative resource meets the requirements of the FHA. In addition, the FHA requirements listed in this document focus on accessibility at a federal level. Please note that different regulations may vary within state and local jurisdictions. It is the Equal Rights Center's recommendation to always consult with accessibility experts who are familiar with and knowledgeable on all regulations that impact accessibility in multifamily housing.



**Note: Refer to state and local building codes or other HUD-Approved Safe Harbors for further guidance.*

Covered multifamily buildings (see Introduction) may contain covered units which are required to meet the design requirements of the Fair Housing Act. Among other distinguishers, covered units are determined by the following criteria:

- In covered multifamily buildings with elevators, all units are covered units.
- In covered multifamily buildings without an elevator, all ground floor units are covered units. *Note: There may be more than one ground floor in a building due to different grade levels.*

Though multistory units are typically not covered by the FHA regulations, when they are located in buildings with one or more elevators, the primary entry level is covered, and therefore must meet all design requirements of the FHA.

Accessible Entrances

	All buildings containing covered dwelling units have at least one accessible entrance along an accessible route.	<input checked="" type="checkbox"/>
1.1	The accessible entrance is the primary entryway used by guests and other residents. <i>Note: A side or back door cannot serve as the accessible entrance. See FHA Site Impracticality Tests for sites with terrain challenges.</i>	<input checked="" type="checkbox"/>
1.2	The accessible entrance to all buildings provides access to all covered dwelling units.	<input checked="" type="checkbox"/>

Accessible Routes

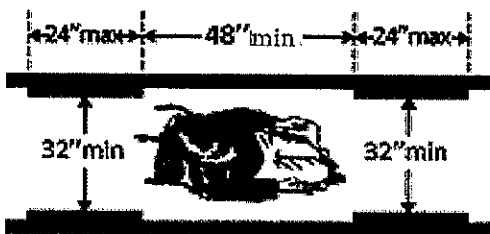
1.3	<p>There is at least one continuous, unobstructed accessible route throughout the community.</p> <p><i>Note: The route does not require the use of stairs.</i></p>	☐
1.4	<p>The accessible route connects all features, elements and spaces of the community to the covered dwelling units.</p> <p><i>Note: Examples include a route leading from site arrival points such as public sidewalks or transportation stops within the site boundary, through the community to all covered buildings, amenities and facilities.</i></p>	☐
1.5	<p>The accessible route is constructed of a firm, stable, and slip-resistant material.</p>	☐
1.6	<p>The accessible route maintains a minimum width of 36 inches.</p>	☐
1.7	<p>The accessible route reduces to no less than 32 inches (at doorways or short corridors) for a maximum depth of 24 inches. These narrower portions of the accessible route must be separated by at least 48 inches of travel space.</p> 	☐



In instances where an accessible route makes a 180 degree turn around an object that is less than 48 inches wide:

- The accessible route has a clear width of 42 inches minimum approaching the turn, 48 inches minimum at the turn, and 42 inches minimum leaving the turn; or
- The accessible route has a clear width of 36 inches minimum approaching the turn, 60 inches minimum at the turn, and 36 inches minimum leaving the turn.

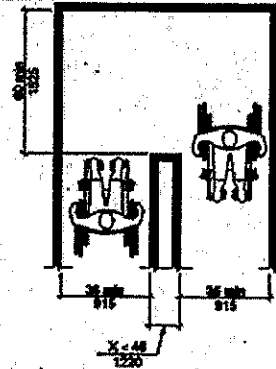
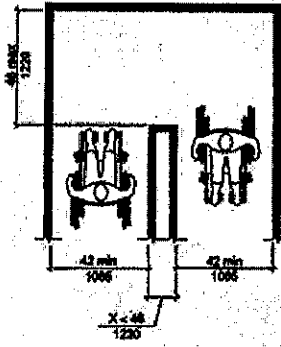

1.8

The accessible route maintains a running slope no greater than 1:20 (5%).

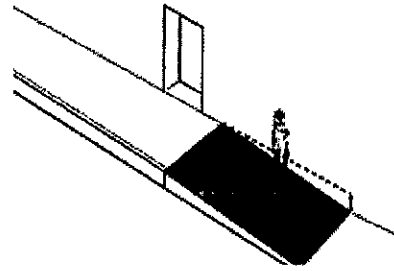

1.9

The accessible route maintains a cross slope no greater than 1:48 (2%).

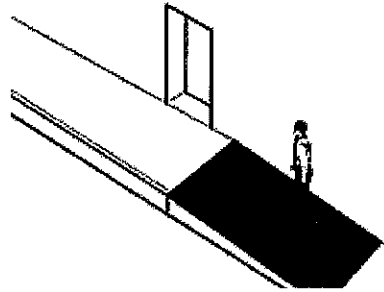

1.10



1.11

There is a minimum 60 x 60 inch passing space for every 200 feet along the accessible route.

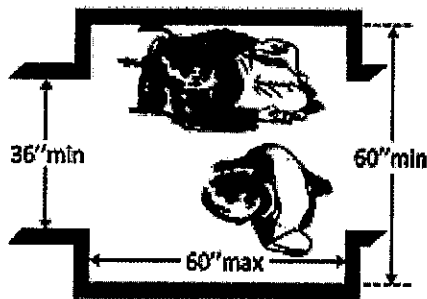

1.12

Grates or other openings along the route are no larger than 1/2 inch.

Openings are positioned with the long dimension perpendicular to the dominant direction of travel.

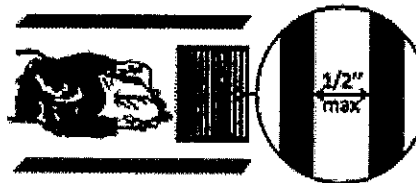

1.13

Changes in level along the route are no greater than 1/4 inch in height, or 1/2 inch if beveled with a slope no greater than 1:2.

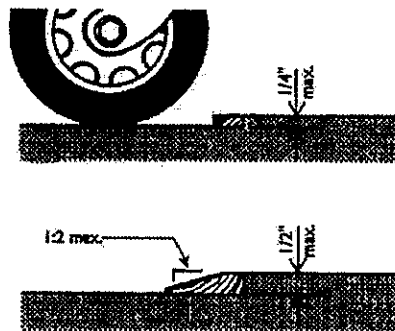

1.14

Changes in level along the route that are greater than 1/2 inch must be ramped with a slope no greater than 1:12 (8.33%).

Note: See Sections 2.9 - 2.17 for ramp requirements.



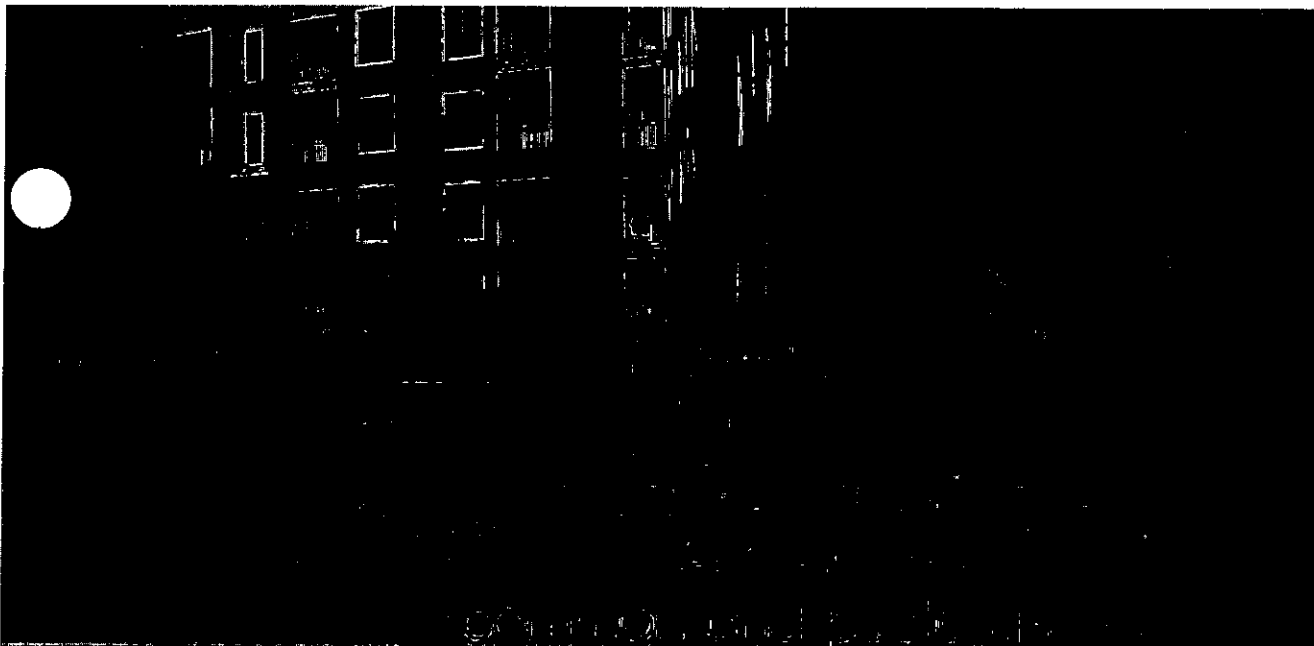

**Note: Refer to state and local building codes or other HUD-Approved Safe Harbors for further guidance.*

The Fair Housing Act requires newly constructed housing developments with covered buildings to have accessible common and public use areas. Common use areas are rooms, spaces and elements inside or outside of a building that are made available for the use of residents and guests of residents, including laundry rooms, swimming pools, fitness centers, and recreational clubhouses. Public use areas within a housing community are areas that are open to the general public such as leasing offices, public parking spaces, and public restrooms. In addition to FHA requirements, public use areas are subject to Title III of the Americans with Disabilities Act (ADA).

Although the intent of the Fair Housing Act Checklist is to highlight FHA regulations, ADA regulations which apply to certain areas within housing developments have been included. All ADA Regulations cited in this Checklist are based on the 2010 ADA Standards.



Public Use Areas

2.1

Elements of public use areas are compliant with applicable ADA regulations.

Note: To ensure compliance with accessibility regulations in public use areas, reference the appropriate ADA guidance: the 1991 ADA Standards for Accessible Design or the 2010 ADA Standards for Accessible Design.

Common Use Areas

2.2

There is an accessible route leading from all covered dwelling units to at least one of each type of common use area.



Note: Examples of common use areas include: tennis courts, swimming pools, fitness centers, recreational clubhouses, etc.

2.3

There is an accessible route leading to at least one of each type of feature within each common use area. Examples include:



- Fitness equipment within fitness centers
- Laundry machines and folding tables within laundry rooms
- Pool tables and games within clubhouses

2.4

Elements of common use areas are accessible to people with disabilities (e.g., kitchens, bathrooms, etc.).



Note: To ensure compliance with accessibility regulations in common use areas, reference the ANSI Standard A117.1 or another HUD-approved Safe Harbor.



Protruding Objects

2.5

Wall mounted objects located between 27 and 80 inches above the finished floor (AFF) have leading edges that do not protrude more than 4 inches from the wall.

Note: The protruding object requirement applies to all circulation paths (e.g., hallways, passageways, aisles, routes, etc.).

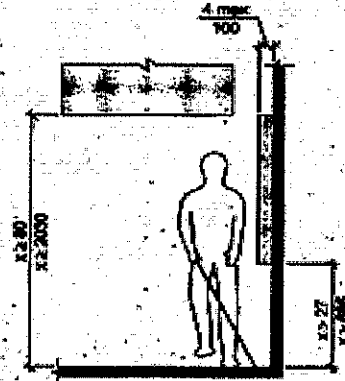

Fig. 207.2 Limits of Protruding Objects



2.6

A vertical clearance of at least 80 inches AFF is provided along the accessible route (e.g., stairwells, doorways, etc.).

In instances where the vertical clearance is less than 80 inches, guardrails or other barriers are provided to assist with detection (e.g., barriers must be provided below open stairwells).

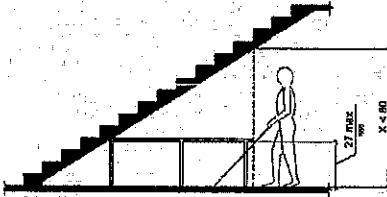

2.7

There is at least a continuous 36-inch route around all obstacles or protruding objects such as fire extinguishers, aesthetic displays, shelving, light fixtures, water fountains, etc.



2.8

The route does not reduce to less than 32 inches for no more than 24 inches maximum.

Note: These narrower portions of the route must be positioned at least 48 inches apart.

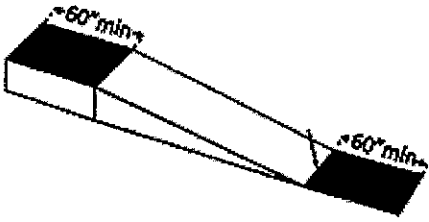
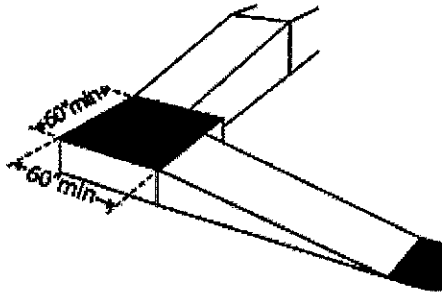

Ramps

2.9	Ramps along an accessible route are at least 36 inches wide between handrails.	<input type="checkbox"/>
2.10	The surface of the ramp is made of a firm, stable, and slip-resistant material.	<input type="checkbox"/>
2.11	The ramp maintains a running slope no greater than 1:12 (8.33%). <i>Note: Any accessible route with a running slope greater than 1:20 (5%) is considered a ramp and will need to comply with requirements accordingly.</i>	<input type="checkbox"/>
	The ramp maintains a cross slope no greater than 1:48 (2%).	<input type="checkbox"/>
2.12	The total rise of each ramp run does not exceed 30 inches.	<input type="checkbox"/>
2.13	<p>There is a level landing at the top and bottom of the ramp with a slope no greater than 1:48 (2%) in all directions.</p> <p>The landings are at least 60 inches long and at least as wide as the ramp.</p>	 <input type="checkbox"/> <input type="checkbox"/>
2.14	<p>There is a level landing (slope no greater than 2% in all directions) where the ramp changes direction that is at least 60 x 60 inches.</p>	 <input type="checkbox"/>



2.15

When the ramp has a rise greater than 6 inches, there are continuous handrails on both sides of the ramp.

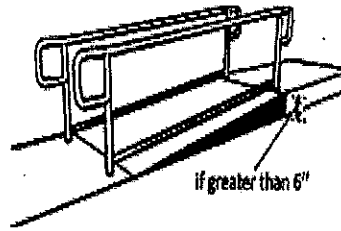

2.16

Handrails do not encroach into the ramp width or into the clear space at landings.



The top of the handrail gripping surface is located between 34 and 38 inches above the ramp surface.

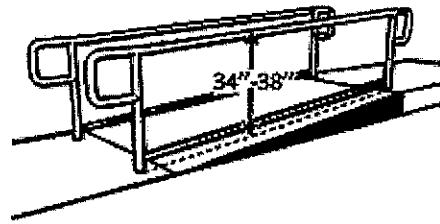

2.17

Ramp handrails extend at least 12 inches beyond the run of the ramp.

All handrail extensions are parallel with the level landing and do not 'extend' over the ramp run.

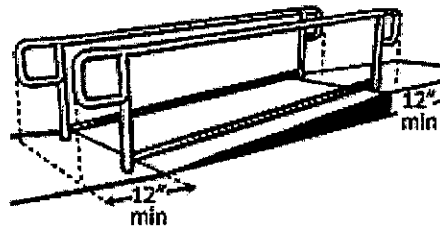

Curb Ramps

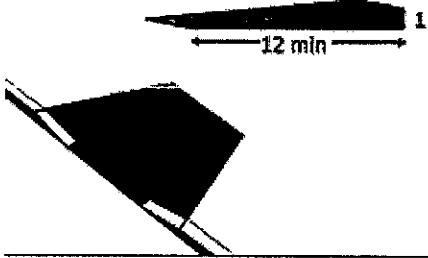
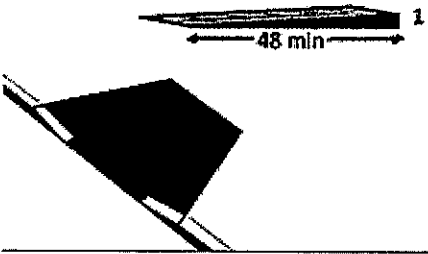
<p>2.18</p>	<p>If the accessible route crosses a curb there is a curb ramp.</p> 	<p><input type="checkbox"/></p>
<p>2.19</p>	<p>The curb ramp is positioned so it does not project into vehicular traffic lanes, parking spaces, or parking access aisles.</p>	<p><input type="checkbox"/></p>
<p>2.20</p>	<p>The running slope of the curb ramp is no greater than 1:12 (8.33%).</p> 	<p><input type="checkbox"/></p>
<p>2.21</p>	<p>The cross slope of the curb ramp, excluding flares, is no greater than 1:48 (2%).</p> 	<p><input type="checkbox"/></p>



2.22

The curb ramp is at least 36 inches wide, excluding side flares.

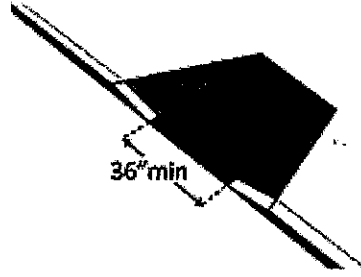

2.23

There is a level landing at the top of the curb ramp with a slope no greater than 1:48 (2%) in all directions.

The level landing is at least 36 inches long and at least as wide as the curb ramp.

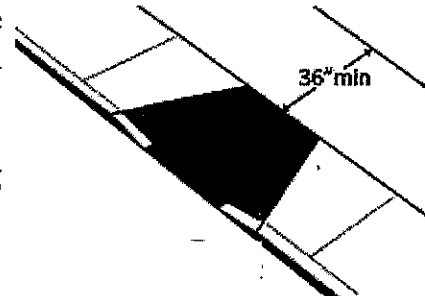

2.24

When the level landing at the top of the curb ramp is greater than 48 inches wide, the curb ramp side flares have slopes no greater than 1:10 (10%).

When the level landing at the top of the curb ramp is less than 48 inches wide, the curb ramp side flares have slopes no greater than 1:12 (8.33%).



2.25

All curb ramps have an area with detectable warnings (e.g., truncated domes) at least 24 inches deep and at least as wide as the curb ramp.



2.26

All curb ramps adjoin an accessible route with a slope no greater than 1:20 (5%).



Parking For Residents and Guests of Residents

Common Use Areas

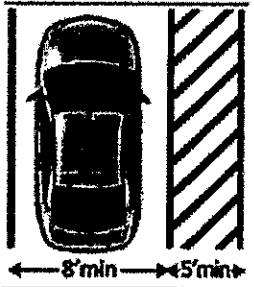
2.27	In areas where parking is provided for residents or guests of residents, at least 2% of the spaces are accessible.	<input type="checkbox"/>
2.28	In areas designated for visitor parking, at least one accessible space is provided. <i>Note: This is in addition to the requirement cited in Section 2.27.</i>	<input type="checkbox"/>
2.29	If additional parking is provided at an amenity (e.g., a clubhouse), at least one accessible space is provided. <i>Note: This is in addition to the requirement cited in Section 2.27.</i>	<input type="checkbox"/>
2.30	There is at least one accessible space per each type of residential parking provided (e.g., covered, carport, surface parking, etc.). <i>Note: This is in addition to the requirement cited in Section 2.27.</i>	<input type="checkbox"/>
2.31	<p>Accessible parking spaces are at least 96 inches wide, and served by an adjacent 60-inch wide access aisle.</p> 	<input type="checkbox"/>
	The access aisle is connected to an accessible route.	<input type="checkbox"/>
	The slope of the accessible parking space and access aisle is no greater than 1:48 (2%) in all directions.	<input type="checkbox"/>

Parking at Public Use Areas

(Note: Regulations are based on the 2010 ADA Standards)

In areas where parking is provided for the public, there are an adequate number of accessible spaces provided as required by the ADA (see table).

Note: Dimensions for accessible car spaces are listed in Section 2.31.

total spaces	accessible spaces
1 - 25	1
26 - 50	2
51 - 75	3
76 - 100	4
100+	see 2010 Standards 208.2

2.32

Among the number of parking spaces that must be accessible, at least one space is van accessible.

2.33

For every 6 or fraction of 6 accessible parking spaces required, at least one must be a van accessible space.



2.34

The van accessible space is:

- At least 132 inches wide served by an adjacent 60 inch-wide access aisle; or
- At least 96 inches wide served by an adjacent 96 inch-wide access aisle.

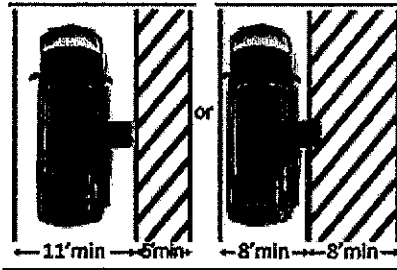

2.35

There is a minimum 98 inches of vertical clearance provided for the van accessible space.

The 98 inches of vertical clearance is maintained at the garage entry as well as throughout the route leading to and from the space.

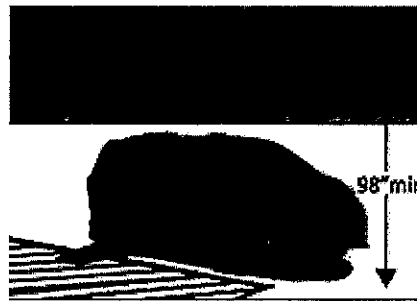

2.36

The access aisle is clearly marked with lines to indicate that it is not a parking space.

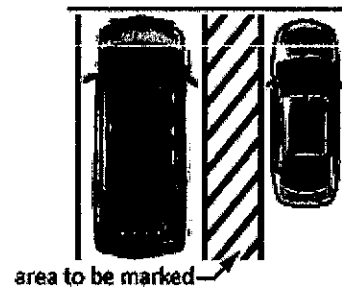

2.37

The slope of the accessible parking space and access aisle is no greater than 1:48 (2%) in all directions.



2.38

The access aisle is connected to an accessible route.



All accessible spaces are indicated with a sign that includes the International Symbol of Accessibility.



The bottom of the sign is positioned at least 60 inches above the ground.



2.39

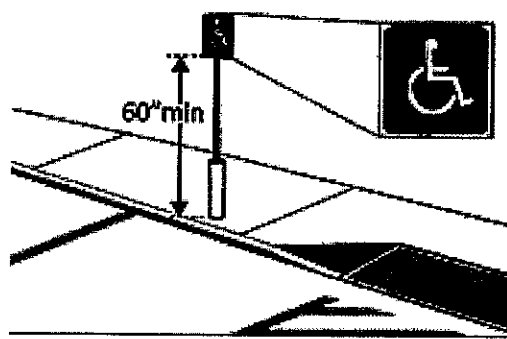

All van accessible spaces are indicated by signs marked "Van Accessible".



2.40

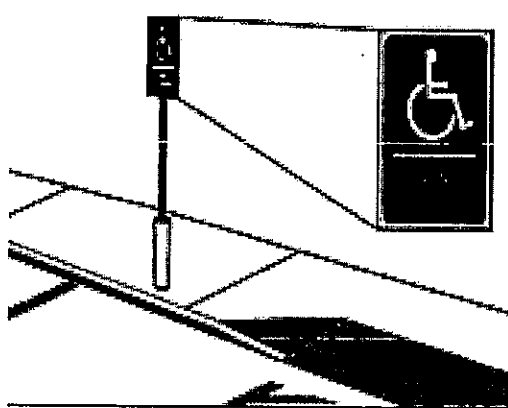

The accessible spaces are located on the closest accessible route to the nearest accessible entrance.



2.41

Mailbox Kiosks

<p>2.42</p>	<p>In buildings with elevators, the operable parts of all mailboxes are within the following acceptable reach ranges:</p> <ul style="list-style-type: none"> • Between 15 and 48 inches AFF with 30 x 48 inches of clear floor space positioned for a forward approach; or • Between 9 and 54 inches AFF with 30 x 48 inches of clear floor space positioned for a side parallel approach. <p><i>Note: Reach range requirements of the FHA differs from those required by the US Postal Service. Install mailbox suites according to both the Requirements of the FHA and the US Postal Service.</i></p>	<p><input type="checkbox"/></p> <p><input type="checkbox"/></p>
<p>2.43</p>	<p>In buildings without elevators, operable parts of all mailboxes serving all covered dwelling units located on the ground floor are within an acceptable reach range (as cited above).</p>	<p><input type="checkbox"/></p>

Accessible Restrooms (Common Use Areas)

<p>2.44</p>	<p>All toilet rooms and bathing facilities in common use areas are located on an accessible route.</p> <hr/> <p>At least one of each fixture in each room or space is accessible.</p> <p><i>Note: All other fixtures and elements of the restroom are accessible as determined by the ANSI Standard A117.1 or another HUD-approved Safe Harbor.</i></p>	<p><input type="checkbox"/></p> <p><input type="checkbox"/></p>
-------------	---	---



FHA accessible restroom stalls meet one of the following designs:

Note: See ANSI Standard for scoping and further guidance.

Standard Stall: 60" Wide

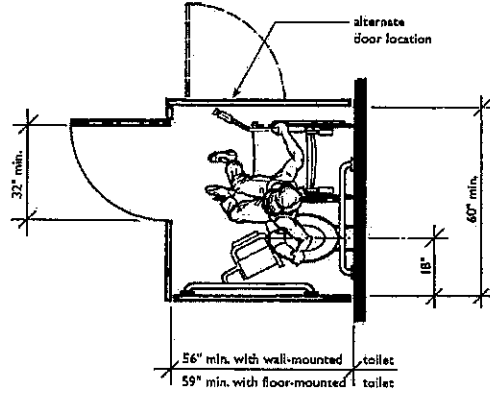

2.45

Alternate Stall 1: 36" Wide

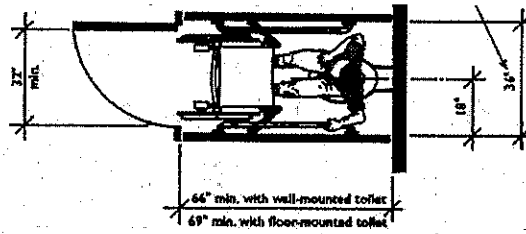

Alternate Stall 2: 48" Wide

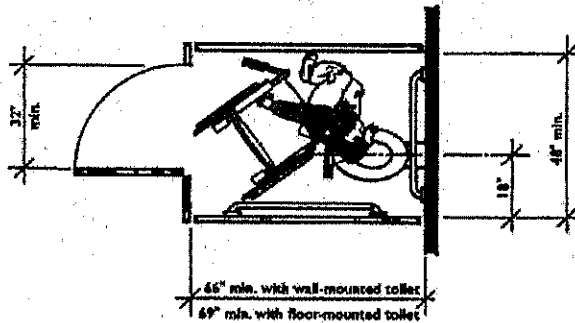



**Note: Refer to state and local building codes or other HUD-Approved Safe Harbors for further guidance.*

Accessible doors are part of the accessible route in public and common use spaces including:

- Main building entrances
- Doors to and within clubhouses, public restrooms, laundry rooms, rental offices, etc.
- Primary entry doors to dwelling units

Usable doors are doors located in the interior of a covered dwelling unit that are intended for user passage.

Accessible Doors

3.1

Accessible doors have a clear opening of at least 32 inches between the face of the door and the stop, when the door is open 90 degrees.

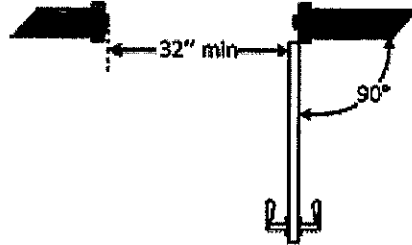

3.2

The front approach to the pull side of the door has at least 18 inches of maneuvering clearance beyond the latch side and at least 60 inches of space perpendicular to the door wall.

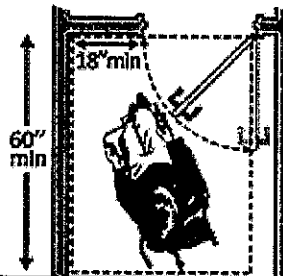

3.3

Door thresholds are no more than 1/4 inch high or 1/2 inch high if beveled with a slope no greater than 1:2.



3.4

Door hardware is operable with one hand and does not require grasping, pinching, or twisting of the wrist.

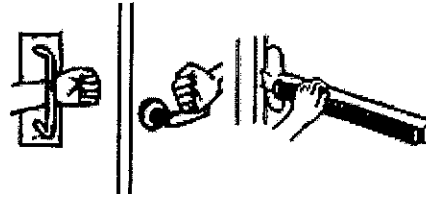

3.5

Operable parts of the door hardware are mounted between 34 inches and 48 inches AFF.

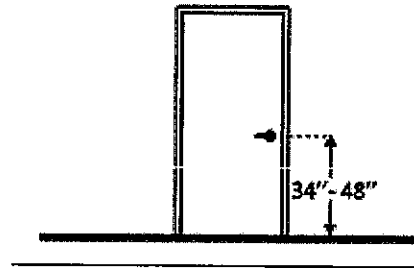

3.6

Doors with closers take no less than 5 seconds to close from an open position of 90 degrees to a position of 12 degrees from the latch.

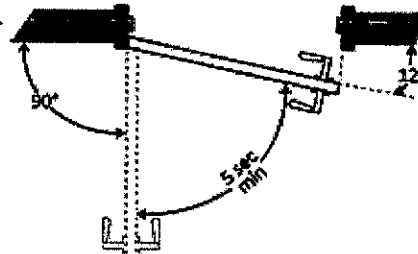

In instances where there are two doors in a series, (e.g., a vestibule), the distance between the doors is at least 48 inches outside the swing of the doors when:

- One door swings into the space (*figure a*);
- Both doors swing out of the space (*figure b*); or
- Both doors swing into the space (*figure c*).

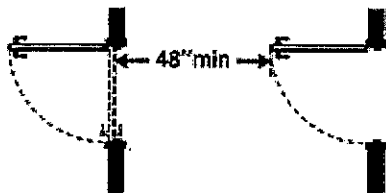

figure a.

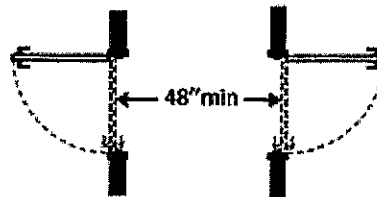

figure b.

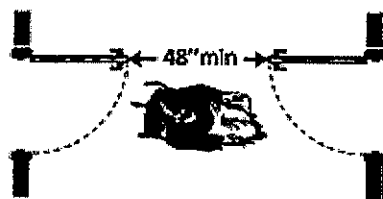

figure c.

3.7



In instances where doorway depth is greater than 24 inches, the doorway opening has been increased to at least 36 inches.

3.8



Maneuvering clearances for swinging doors comply with one of the following configurations:

Type of Use		Maneuvering Clearance	
Approach Direction	Door Side	Perpendicular to Doorway	Parallel to Doorway (beyond latch)
From front	Pull	60 inches	18 inches
From front	Pull	48 inches	0 inches
From front	Pull	60 inches	36 inches
From front	Pull	54 inches	42 inches
From front	Pull	42 inches	22 inches
From front	Pull	48 inches	24 inches
From front	Pull	42 inches	24 inches

Approach Direction	Door Side	Perpendicular to Doorway	Parallel to Doorway (beyond latch)
From front	Pull	60 inches	18 inches
From front	Pull	48 inches	0 inches
From front	Pull	60 inches	36 inches
From front	Pull	54 inches	42 inches
From front	Pull	42 inches	22 inches
From front	Pull	48 inches	24 inches
From front	Pull	42 inches	24 inches

3.9

3.10

Interior hinged doors take no more than 5 lbs of pressure to push or pull open.

3.11

Fire doors have the minimum opening force allowable by the appropriate administrative authority.

Usable Doors

Usable Doors are doors within the unit that are intended for user passage such as bathroom, bedroom, and utility room doors, among others.

3.12	<p>Usable doors have a clear opening of at least a nominal 32 inches (no less than 31 and 5/8 inches) between the face of the door and the stop, when the door is open to 90 degrees.</p> <p><i>Note: Because of normal installation practices, usable doorways can vary from the 32-inch clear width by a "nominal" amount. Tolerances of 1/4 inch to 3/8 inch are considered an acceptable range for usable doors.</i></p>	<input type="checkbox"/>
3.13	<p>Door thresholds are no more than 1/4 inch high or 1/2 inch high if beveled with a slope no greater than 1:2.</p>	<input type="checkbox"/>
3.14	<p>Doors leading to closets with a depth greater than 24 inches have a nominal 32-inch clear width.</p> <p><i>Note: This is an FHA best practice.</i></p>	<input type="checkbox"/>
3.15	<p>All secondary doors that provide passage onto exterior areas of the unit (decks, patios, balconies, etc.) have a nominal 32-inch clear width.</p>	<input type="checkbox"/>



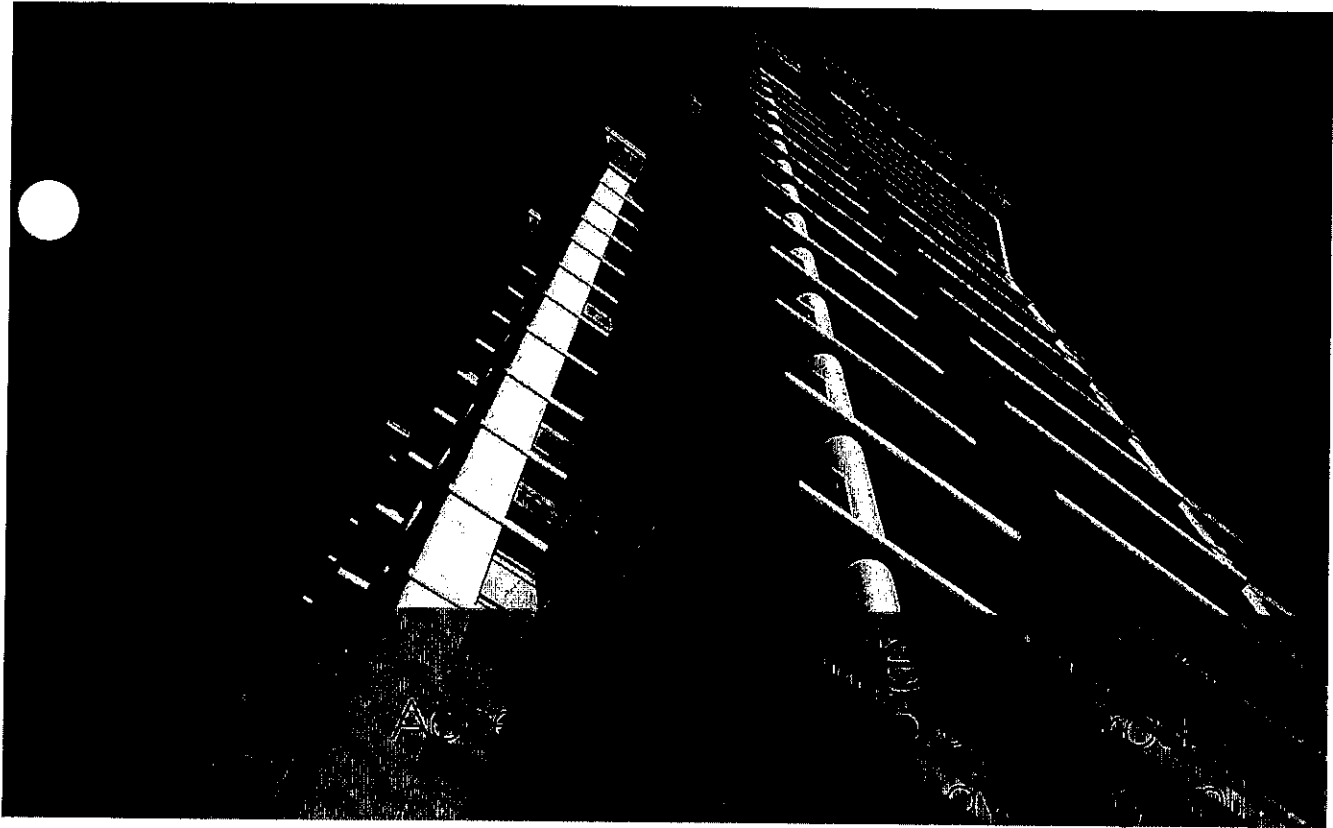

**Note: Refer to state and local building codes or other HUD-Approved Safe Harbors for further guidance.*

All areas within covered dwelling units, including secondary exterior spaces such as balconies and terraces, must be connected by an accessible route.



Accessible Routes

The entry door to the unit meets the Accessible Door requirements as indicated in Section 3.



4.1

Note: FHA requirements allow primary entry doors to units to have a threshold no higher than 3/4 inch if beveled with a slope no greater than 1:2.



25



<p>4.2</p>	<p>There is an accessible route starting at the main entry door that leads, uninterrupted, through each room and connects to all spaces and elements within the unit (e.g., bedrooms, bathrooms, living room, etc.).</p> <p><i>Note: The FHA does not require an accessible route to unfinished basements or garages.</i></p>	<input type="checkbox"/>
<p>4.3</p>	<p>The route maintains at least 36 inches in width throughout the unit.</p>	<input type="checkbox"/>
<p>4.4</p>	<p>Throughout the interior of the unit, changes in level are no more than ¼ inch high or ½ inch high if beveled with a slope no greater than 1:2.</p>	<input type="checkbox"/>
	<p>Changes in level greater than ½ inch high are ramped with a slope no greater than 1:12 (8.33%).</p>	<input type="checkbox"/>
<p>4.5</p>	<p>In instances where there is a loft, it takes up no more than 33 and 1/3 percent of the floor area of the room in which it is present.</p>	<input type="checkbox"/>
<p>4.6</p>	<p>In instances where the unit is a multistory unit in a covered building with an elevator:</p> <ul style="list-style-type: none"> • The primary entry to the unit is located on the same floor that is served by the elevator; and • The story served by the elevator meets FHA Requirements 3-7 (see Sections 3-7 for guidance). 	<input type="checkbox"/> <input type="checkbox"/>



Thresholds & Changes in Level at Exterior Primary and Secondary Doors

Changes in level vary depending on whether the door is a primary or secondary door and the makeup of the material of the outside landing surface. Measurements for changes in level should be taken from the finished floor or fully compressed carpet.

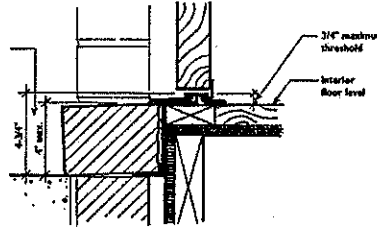
4.7	<p>In instances where the primary entry door to a dwelling unit has direct exterior access (e.g., a garden style building):</p> <ul style="list-style-type: none"> If the landing material outside of the door is pervious, the exterior floor is level with the interior floor of the dwelling unit. 	<input type="checkbox"/>
	<ul style="list-style-type: none"> If the landing material outside of the door is impervious, the exterior floor is no more than ½ inch below the interior floor of the dwelling unit. Thresholds at these doors are a maximum ¾ inch plus the change in level noted above. They must be beveled at a slope no greater than 1:2. <p><i>Note: This could allow an exterior maximum rise of 1-¼ inch, which must be beveled with a slope no greater than 1:2.</i></p>	<input type="checkbox"/>
	<p>In instances where secondary doors lead to decks, patios, balconies, etc.:</p> <ul style="list-style-type: none"> If the landing material outside of the door is pervious, the change in level is no more than ½ inch on the exterior side. 	<input type="checkbox"/>
4.8	<ul style="list-style-type: none"> If the landing material outside of the door is impervious, the change in level is no more than 4 inches on the exterior side. Thresholds at these doors are a maximum ¾ inch plus the change in level noted above. The threshold must be beveled at a slope no greater than 1:2. <p><i>Note: This could allow an exterior maximum rise of 4-¾ inch (see image).</i></p>	<input type="checkbox"/>
		<input type="checkbox"/>

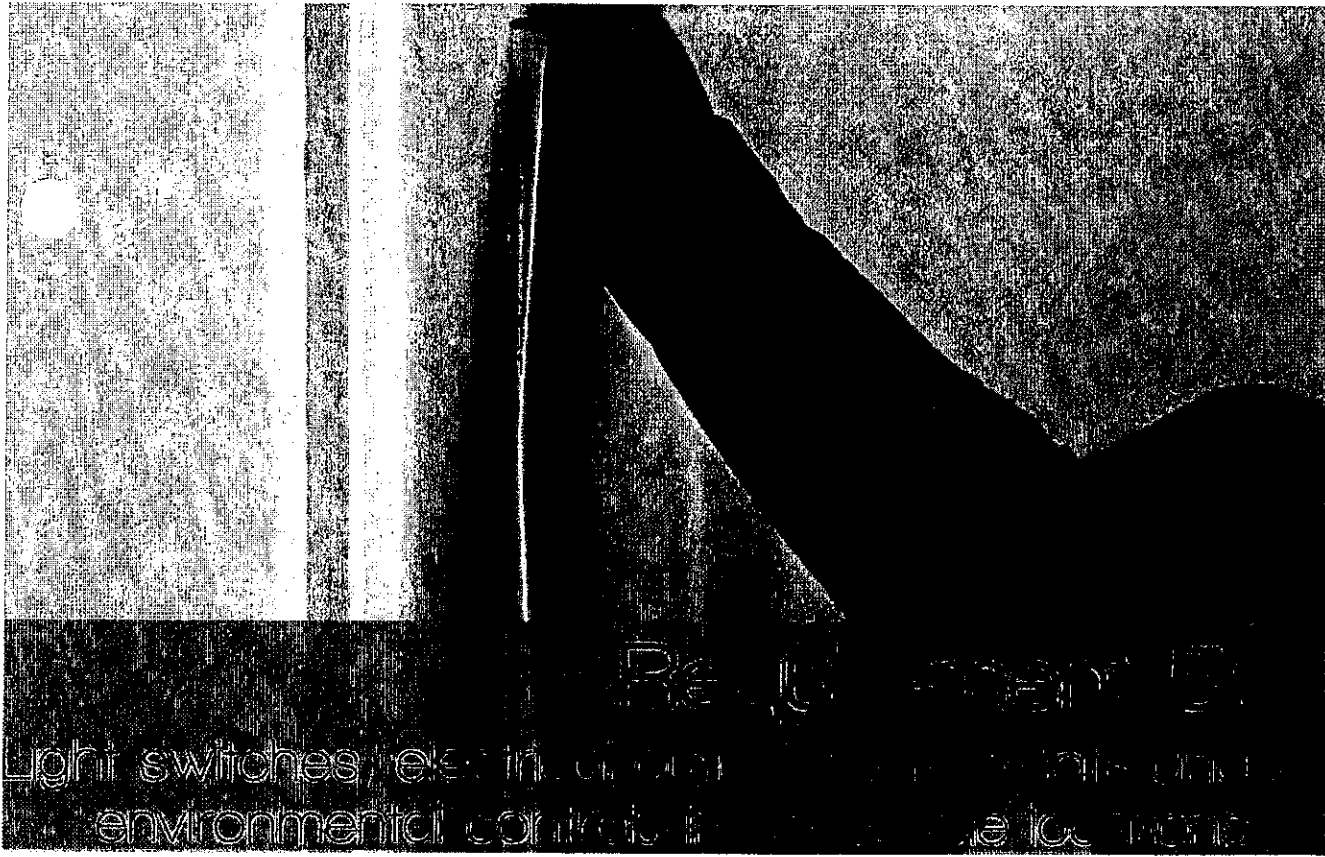

**Note: Refer to state and local building codes or other HUD-Approved Safe Harbors for further guidance.*

Environmental controls, light switches, and electrical outlets are required to be placed in accessible locations. Environmental controls include heating and cooling controls (such as thermostats), ceiling fans, automated skylights, etc.

Controls **not** covered by the FHA include: controls on appliances including ranges and washing machines, exhaust fan controls such as those which are an integral part of hoods installed above ranges, circuit breakers, and telephone jacks, among others.

Note: Guidelines allow for controls or outlets that do not satisfy the requirements, if comparable controls or outlets are provided in the same area.



5.1

In instances where there is a forward reach with no barrier:

- Controls, outlets, and switches are mounted no lower than 15 inches and no higher than 48 inches AFF; and
- There is 30 x 48 inches of clear floor space at the control to allow for a forward approach.

Note: The height measurement is taken at the highest and lowest operable points of the control.



5.2

In instances where a forward reach is obstructed by a barrier that is less than 20 inches:

- Controls, outlets, and switches are mounted no higher than 48 inches AFF; and
- Knee space clearance of at least 27 inches AFF is provided; and
- There is 30 x 48 inches of clear floor space at the control to allow for a forward approach.



5.3

In instances where a forward reach is obstructed by a barrier that is more than 20 inches but less than 25 inches:

- Controls, outlets, and switches are mounted no higher than 44 inches AFF; and
- Knee space clearance of at least 27 inches AFF is provided; and
- There is 30 x 48 inches of clear floor space at the control to allow for a forward approach.

Note: HUD allows a maximum countertop projection of 25 ½ inches

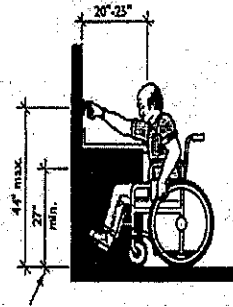

5.4

In instances where there is a side reach over an obstruction of up to 10 inches, controls, outlets, and switches are mounted no higher than 48 inches AFF.

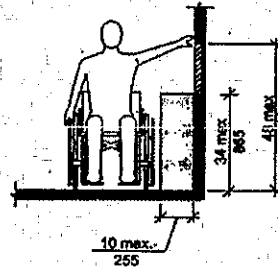

5.5

In instances where there is a side reach over an obstruction greater than 10 inches but less than 24 inches, controls, outlets, and switches are mounted no higher than 46 inches AFF.

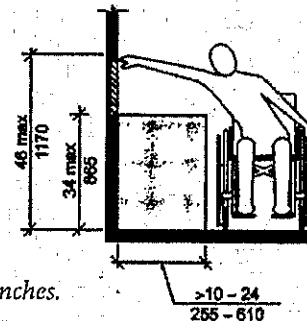

Note: HUD allows a maximum countertop projection of 25 ½ inches.



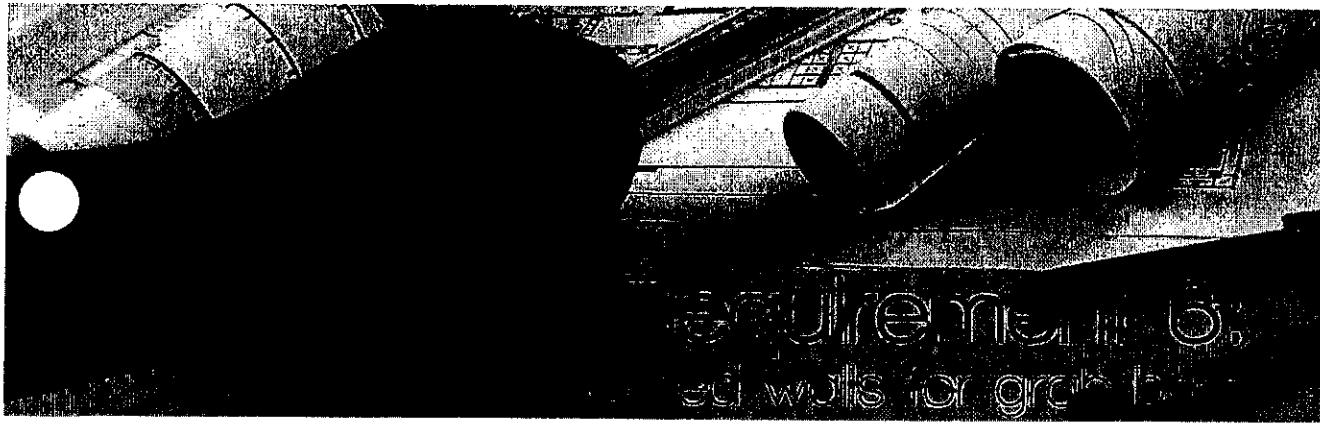

**Note: Refer to state and local building codes or other HUD-Approved Safe Harbors for further guidance.*

Reinforced walls are required in all bathrooms in a covered dwelling unit. In addition, powder rooms in multistory units in elevator buildings where the powder room is the only toilet facility on the entry level are required to have reinforced walls.

There are no specified materials for reinforcing. It is common to use cut-off from framing, plywood, or metal plates.

Reinforced Walls

6.1 There is wall reinforcement of at least 6 inches wide by 24 inches long provided centered behind the toilet.

The reinforced area is positioned between 32 inches maximum AFF at the bottom edge and 38 inches minimum AFF at the top edge.

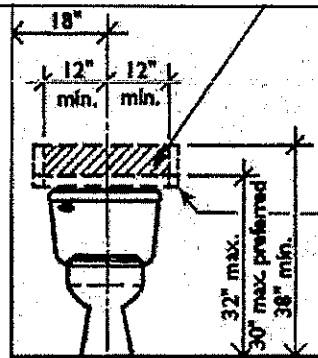

6.2 There is wall reinforcement of at least 6 inches wide by 24 inches long provided adjacent to the toilet.

The reinforced area is positioned between 32 inches maximum AFF at the bottom edge and 38 inches minimum AFF at the top edge.

The leading edge of the wall reinforcement beside the toilet is positioned at least 36 inches from the back wall.

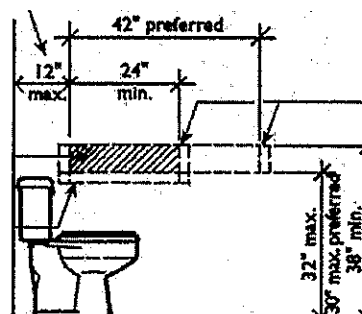

6.3

In bathrooms where the toilet is not adjacent to a wall, the floor or wall is reinforced for folding or floor-mounted grab bars.



6.4

There is wall reinforcement of at least 6 inches wide by 24 inches long provided at the head and foot (control wall) of the tub.

The reinforced areas are positioned between 32 inches maximum AFF at the bottom edge and 38 inches minimum AFF at the top edge.

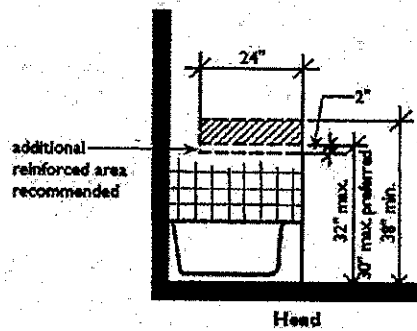

6.5

The back wall of the tub is reinforced so that there is no greater than 6 inches of non-reinforced area on either side. The reinforced area of the tub stops at a minimum of 38 inches AFF at the top edge.

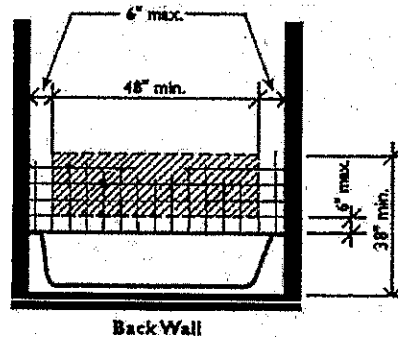

6.6

In instances where showers are the only bathing fixture in the unit, or on the entry level of a multistory unit in a building with an elevator:

- There is a wall reinforcement of at least 6 inches provided on all walls of the shower

Note: Glass walls are not required to be reinforced.

- The reinforced area is positioned between 32 inches maximum AFF at the bottom edge and 38 inches minimum AFF at the top edge.

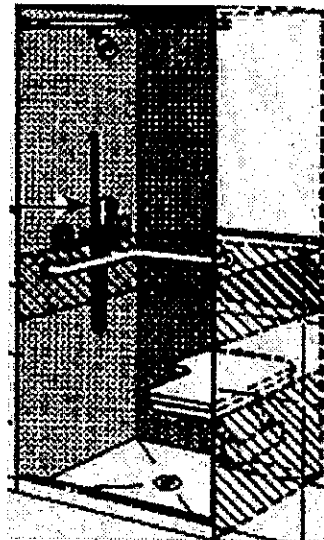

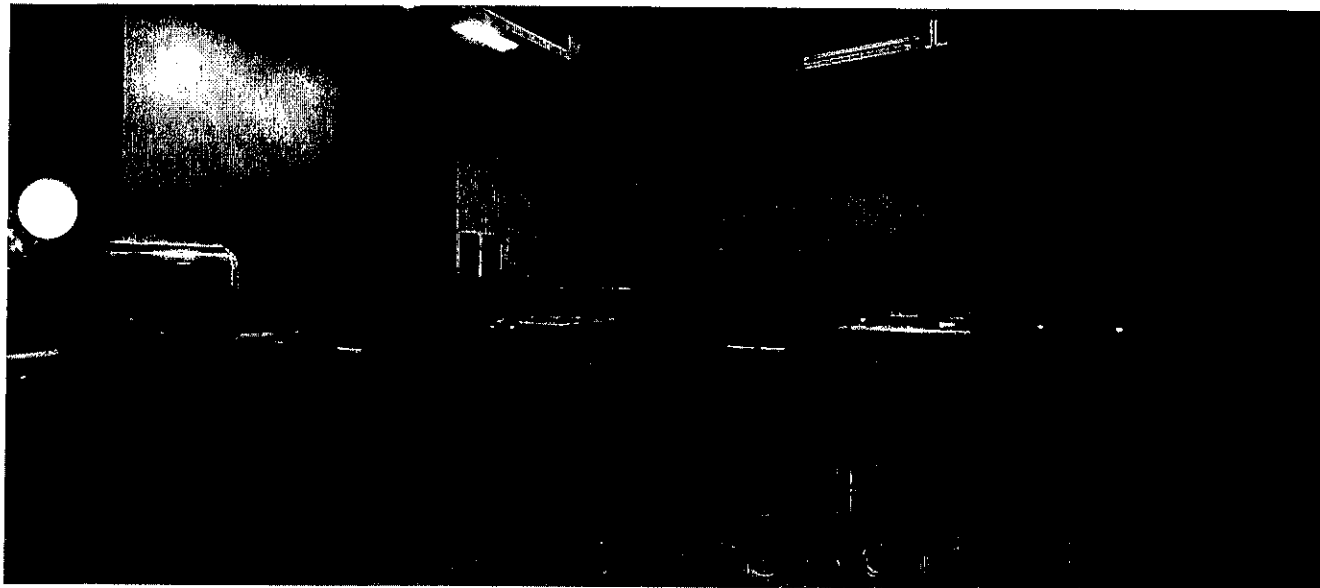

**Note: Refer to state and local building codes or other HUD-Approved Safe Harbors for further guidance.*

Usable kitchen and bathrooms are included under Requirement 7 of the Fair Housing Act. Both require clear floor space positioned at fixtures and proper clearance, among other criteria, in order to provide accessibility to people with disabilities.

Usable Kitchens

7.1 There is 30 x 48 inches of clear floor space centered on the sink to allow for a parallel approach.

Note: This measurement is taken from the center of the sink basin.

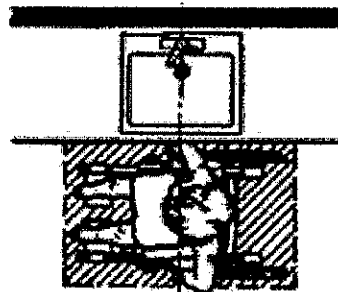

7.2 In instances where there are multiple sink bowls, there is 30 x 48 inches of clear floor space centered on the overall sink.

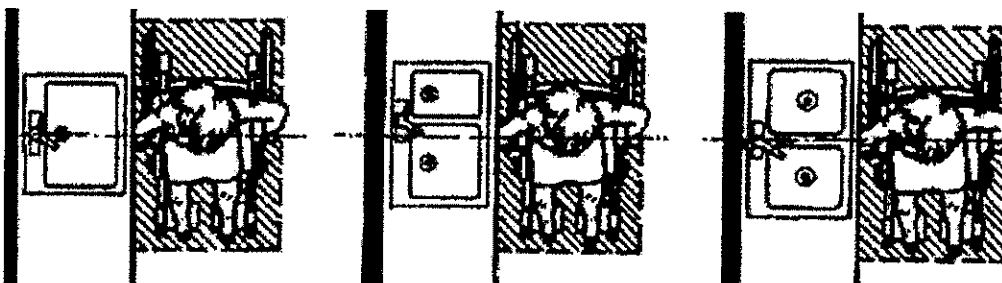

7.3

There is 30 x 48 inches of clear floor space centered on the cooktop/range to allow for a parallel approach.

Note: Cooktops with removable base cabinets that allow for knee clearance of at least 30 inches wide by at least 27 inches high can have a centered forward approach.

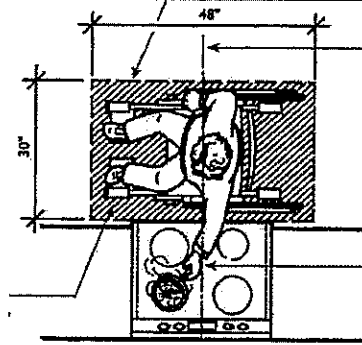

7.4

Additional appliances such as refrigerators, dishwashers, freezers, wall-mounted microwaves/ovens, and trash compactors have 30 x 48 inches of clear floor space for either a:

- Centered parallel approach; or
- Centered forward approach

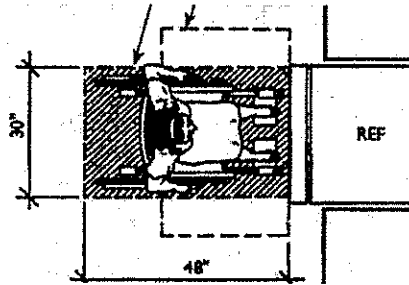

7.5

There is a minimum clearance of 40 inches between all opposing elements within the kitchen work area such as base cabinets, counter top edges, appliances, or walls.

Note: This measurement is taken from the face of the appliance (excluding handles or controls) to whichever opposing element projects the furthest (cabinet face, countertop edge, wall, etc.).

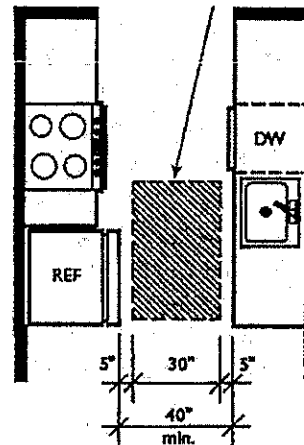

7.6

In instances where kitchens have an island, the 40-inch minimum clearance is maintained around all edges within the kitchen work area.







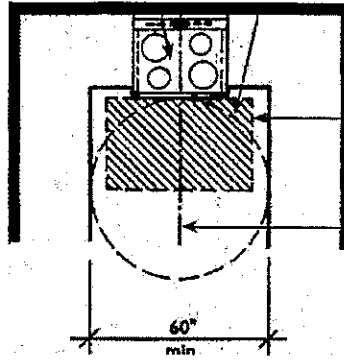

7.7

In U-shaped kitchens, there is a 60-inch diameter turning circle at the base of the kitchen.

Note: The 60-inch diameter turning circle must not be encroached upon by countertops, cabinets, refrigerators (excluding handles), etc.



Narrow U-shaped kitchens (lacking a 60-inch diameter turning circle) meet the following requirements:

- There is at least 40 inches between all opposing elements. 
- The sink or cooktop is located at the base of the kitchen. 
- The sink or cooktop has removable base cabinets that allow for proper knee clearance. 
- There is knee clearance at least 30 inches wide by at least 27 inches high. 
- There is 30 x 48 inches of clear floor space centered on the sink or cooktop for a forward approach (this can include knee space). 
- All pipes are covered by a removable pipe protection and panel, or wrapped with padded insulation materials. 

7.8

Note: Because ranges do not allow for knee space, a narrow U-shaped kitchen with a range at the base will not meet the FHA regulations.

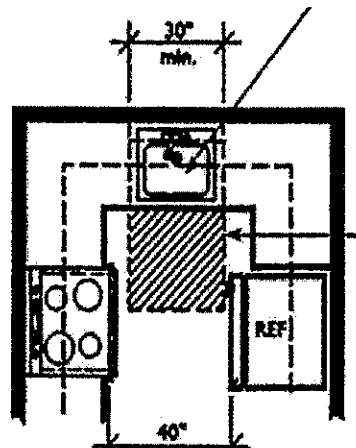

7.9

In instances where electrical outlets and switches are mounted over base cabinets without knee space, the accessible outlets and switches meet the following requirements:

- Electrical outlets and switches are mounted at least 36 inches from any corner to allow for a parallel approach.

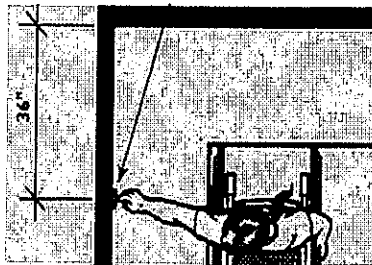

- Electrical outlets and switches are mounted no higher than 46 inches AFF.

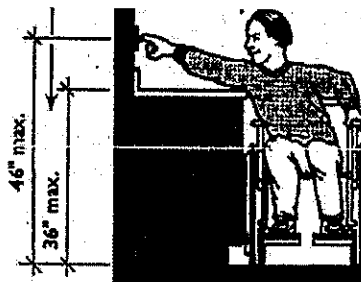

Countertop depths do not exceed 25 inches.

Note: HUD allows a maximum countertop projection of 25 1/2 inches.



7.10

Countertops do not exceed 36 inches in height when measured AFF.



Usable Bathrooms

<p>7.11</p>	<p>Usable bathrooms must meet all FHA requirements including, but not limited to:</p> <ul style="list-style-type: none"> • The bathroom is along an accessible route with a nominal 32-inch clear door opening. • Switches, outlets, and controls are located in accessible locations. • Walls are reinforced for the later installation of grab bars. • There is sufficient maneuvering space within the bathroom to permit a person to enter and exit the room, close and reopen the door, and use fixtures. 	<p><input type="checkbox"/></p> <p><input type="checkbox"/></p> <p><input type="checkbox"/></p> <p><input type="checkbox"/></p>
<p>7.12</p>	<p>In instances where there is a powder room in the unit, the powder room must be:</p> <ul style="list-style-type: none"> • Along an accessible route with a door that provides a nominal 32-inch clear opening; and • Equipped with switches, outlets, and controls in accessible locations. 	<p><input type="checkbox"/></p> <p><input type="checkbox"/></p>
<p>7.13</p>	<p>In instances where the unit is a multistory unit in an elevator building, there is either a usable powder room (Section 7.12) or a usable bathroom (Section 7.11) on the same level that is served by the elevator.</p>	<p><input type="checkbox"/></p>
<p>7.13</p>	<p>If only a powder room is provided on the level that is served by the elevator, it must meet the requirements in Section 7.12 as well as the following:</p> <ul style="list-style-type: none"> • The walls are reinforced for the later installation of grab bars. • There is sufficient maneuvering space within the bathroom to permit a person to enter and exit the room, close and reopen the door, and use fixtures. 	<p><input type="checkbox"/></p> <p><input type="checkbox"/></p>

Specification A and B Bathrooms

The Fair Housing Act provides two sets of specifications to design bathrooms that are usable by people with disabilities. Though there are other differences, Specification B Bathrooms offer greater access to the tub than Specification A Bathrooms.

If the Specification A design is selected, all bathrooms in the unit must comply with Specification A standards (Section 7.14). This includes access to all fixtures in each Specification A Bathroom (e.g., two lavatories in one bathroom would both need to meet FHA regulations).

If the Specification B design is selected, only one bathroom in the unit, and only one of each type of fixture within the bathroom, must comply with Specification B standards (Section 7.15). All other bathrooms in the unit must meet the usable bathroom requirements (Section 7.11), exempting maneuvering clearances and clear floor space requirements at fixtures.

Specification A Bathrooms*

7.14	The door has a minimum clear width of 32 inches nominal and meets all other usable door requirements (Sections 3.12–3.13).	<input type="checkbox"/>
	There is 30 x 48 inches of clear floor space outside the swing of the door that provides a forward approach to the tub. <i>Note: A parallel approach to the tub is also possible if proper knee space or removable base cabinets are provided.</i>	<input type="checkbox"/>
	The walls are reinforced for the later installation of grab bars.	<input type="checkbox"/>
	Clear floor space is provided at the lavatory by: <ul style="list-style-type: none"> • 30 x 48 inches of clear floor space parallel to and centered on the sink basin; or • A removable vanity cabinet to provide knee space for a forward approach. <p><i>*Note: For diagram, see page 40.</i></p>	<input type="checkbox"/> <input type="checkbox"/>

Specification B Bathrooms*

7.15

<p>The door has a minimum clear width of 32 inches nominal and meets all other usable door requirements (Sections 3.12–3.13).</p>	<input type="checkbox"/>
<p>There is 30 x 48 inches of clear floor space outside the swing of the door that provides a side approach to the tub.</p>	<input type="checkbox"/>
<p>The walls are reinforced for the later installation of grab bars.</p>	<input type="checkbox"/>
<p>Clear floor space is provided for the lavatory by:</p> <ul style="list-style-type: none"> • 30 x 48 inches of clear floor space parallel to and centered on at least one sink basin; or • A removable vanity cabinet to provide knee space for a forward approach. 	<input type="checkbox"/> <input type="checkbox"/>
<p>In instances where knee space is provided at the lavatory:</p> <ul style="list-style-type: none"> • There is no more than 19 inches of the 30 x 48 inches of required clear floor space extended under the lavatory. • The top fixture rim is a maximum of 34 inches AFF, with the apron at least 27 inches AFF. • The depth of the wall hung or countertop lavatory is at least 17 inches from the wall. 	<input type="checkbox"/> <input type="checkbox"/> <input type="checkbox"/>
<p>In instances where removable cabinetry is provided, pipes are covered for protection by:</p> <ul style="list-style-type: none"> • Insulation around pipes; or • Adding a fixed, one-piece protection panel. <p><i>*Note: For diagrams, see page 40.</i></p>	<input type="checkbox"/> <input type="checkbox"/>

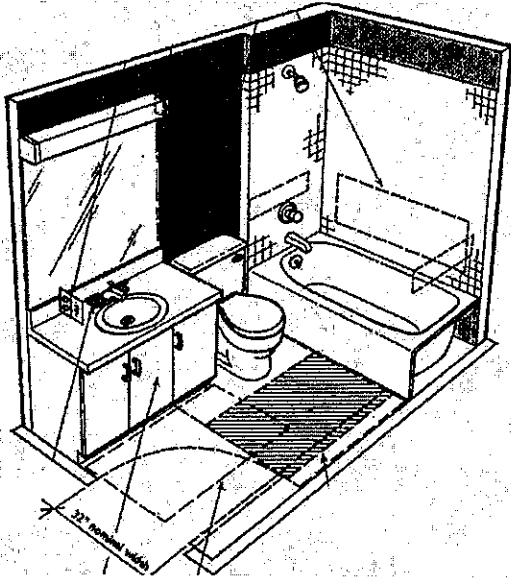

*Specification A Bathroom
(Section 7.14)*

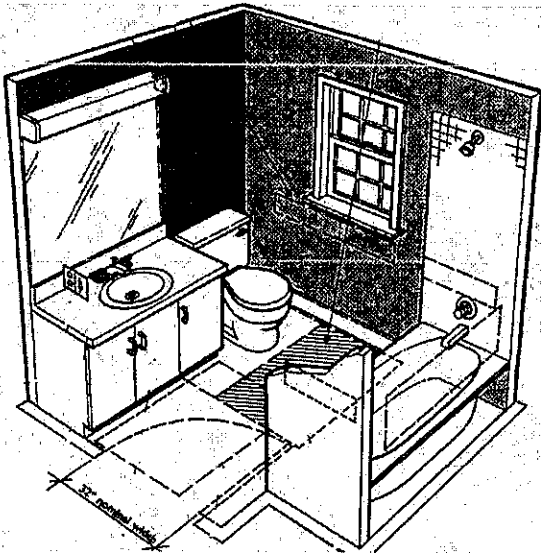

*Specification B Bathroom
(Section 7.15)*



Both Specification A & B Bathroom Toilets

One of the following three clear floor spaces is provided at toilets:

- The centerline of the toilet is 18 inches from the adjacent side wall and at least 15 inches from a wall-hung lavatory or vanity.
- There is a minimum of 48 x 66 inches of clear floor space, excluding the toilet and the wall-hung lavatory or vanity.

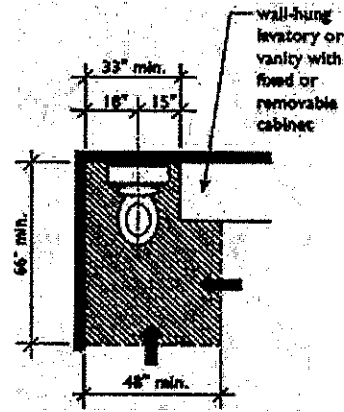

7.16

- The centerline of the toilet is 18 inches from the adjacent side wall and at least 15 inches from a wall-hung lavatory or vanity.
- There is a minimum of 48 x 56 inches of clear floor space, excluding the toilet and the wall-hung lavatory or vanity.

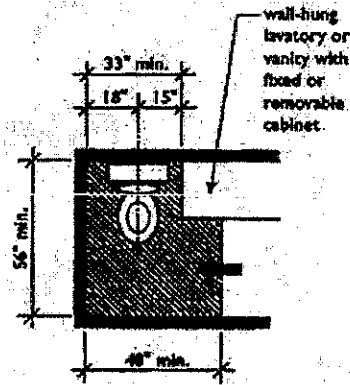

- The centerline of the toilet is 18 inches from the adjacent side wall.
- There is a minimum of 60 x 56 inches of clear floor space, excluding the toilet.

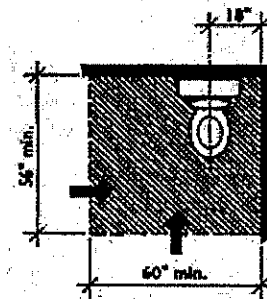

One of the following three clear floor spaces is provided at tubs:

- There is a minimum of 30 x 60 inches of clear floor space adjacent to the tub, excluding a lavatory with knee space.

Note: for use with Specification A bathrooms only.

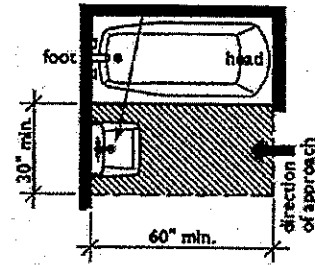

1
Specification "A"
Bathrooms
30" X 60"

- There is a minimum of 48 x 60 inches of clear floor space adjacent to the tub, excluding a toilet with a centerline at least 18 inches from the tub.

Note: for use with Specification A bathrooms only.

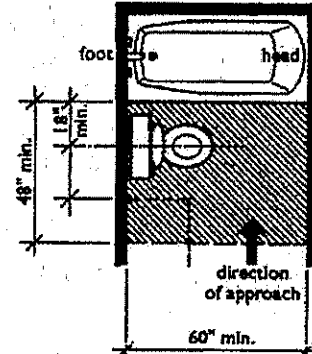

2
Specification "A"
Bathrooms
48" X 60"

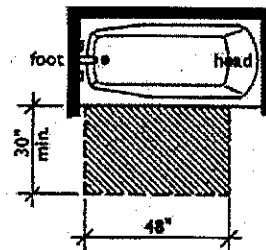

- There is a minimum of 30 x 48 inches of clear floor space adjacent to the tub.



3
Specification "B"
Bathrooms
30" X 48"

7.17

Showers

<p>7.18</p>	<p>Showers in Specification A and Specification B bathrooms that are the only bathing fixture in the unit are at least 36 x 36 inches.</p>	
<p>7.19</p>	<p>In instances where the shower stall is 36 x 36 inches, the 30 x 48 inches of required clear floor space is positioned flush with the control wall and 12 inches offset behind the wall opposite the control wall.</p>	
<p>7.20</p>	<p>In instances where the shower stall is 36 x 48 inches, the 30 x 48 inches of clear floor space is positioned parallel with the fixture and flush with the control wall.</p>	

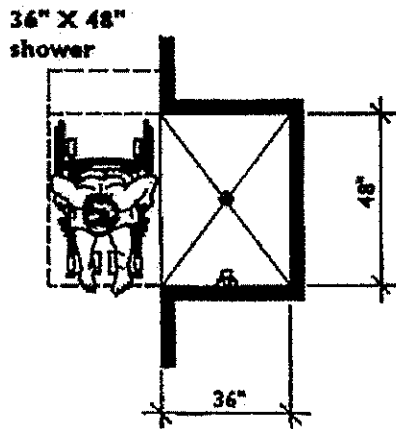
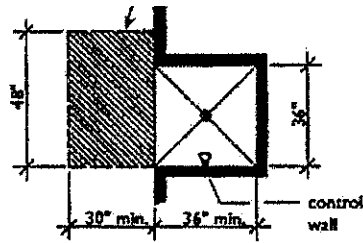

The Equal Rights Center

1119 Pennsylvania Avenue, N.W., Suite 400
Washington, D.C. 20004
(202) 462-3002 (Toll Free)
(202) 462-4372 (Local Area)
1-800-458-7111
(202) 462-1000 (Fax)

www.equalrightscenter.org